

SHEET METAL DESIGN HANDBOOK

Forming Basics.....2

- Critical Dimensions
- Embosses and Offsets
- Bend Radius
- Bend Relief
- Forming Near Holes
- Form height to thickness ratio
- Edge Distortion

Laser cutting.....5

- Tolerances
- Material Restrictions
- Acceptable Materials
- Localized Hardening
- Hole Diameter

CNC Turret Basics.....6

- Tolerances
- Special Forms
- Hole-to-edge clearance
- Hole taper
- Hole diameter
- Feature placement restrictions
- Nibbling Large Radii
- Countersinks

Stamping.....10

- Blanking-Corners
- Notches and Tabs
- Cutoffs
- Piercing Holes
- Edge-to-Hole clearance
- Forming-Bend Relief
- Edge Bulging
- Hole-to-form
- Slot-to-form
- Drawing shapes
- Drawing Radii

Forming Basics

Press brake forming—The fundamental advantage of a press brake as a forming tool is its flexibility. By using standard vee-dies, cost savings can be realized through economical set-ups and run times on small lots and prototypes. In addition to these considerations, using the following guidelines will increase the manufacturability of designs for press brake forming.

Dimension the part in a single direction wherever possible. Because of the sequential nature of the forming process, and the fact that dimensional variation is introduced at each bend, dimensioning in a single direction parallels the process and helps to control tolerance accumulation. Furthermore, allow a more generous bend tolerance ($\pm .007''$) as tighter tolerances, while achievable, will result in higher costs.

Use consistent bend radius for all bends per part, when possible—it helps minimize setup changes. Additionally, we prefer radii specs in fractions of an inch, as our tooling is sized accordingly.

Generally, dimensioning should be done from a feature to an edge. Avoid feature-to-feature dimensions over two or more planes. Feature-to-bend dimensions may require special fixtures or gauging.

This also means that tolerances in the title block of a drawing may be unnecessarily restrictive for certain dimensions and angles, while very appropriate for others.

Critical Dimensions Sheet Metal Forming – Outside dimension should be used unless the inside dimension is critical.

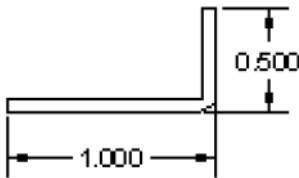

Embosses and Offsets – Emboss and offset dimensions should be to the same side of the material unless the overall height is critical.

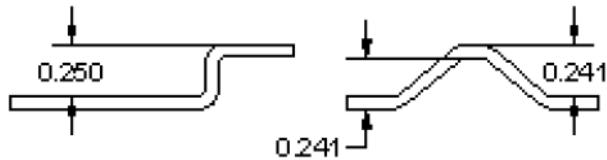

Only the truly critical dimensions should be highlighted as such. Placing excessively high tolerances and redundant critical dimensions can dramatically increase the cost of the part.

Bend Radius- As a rule, inside bend radius should be equal to material thickness. When the radius is less than recommended, this can cause material flow problems in soft material and fracturing in hard material.

Bend Relief - When a bend is made close to an edge the material may tear unless bend relief is given. Figure "A" shows a torn part. Figure "B" shows a part with the edge a sufficient distance from the form. This distance should never be less than the radius of the bend. Figure "C" shows a bend relief cut into the part, again the depth of the relief should be greater than the radius of the bend. The width of the relief should be a material thickness or greater, preferably a material thickness + 1/64".

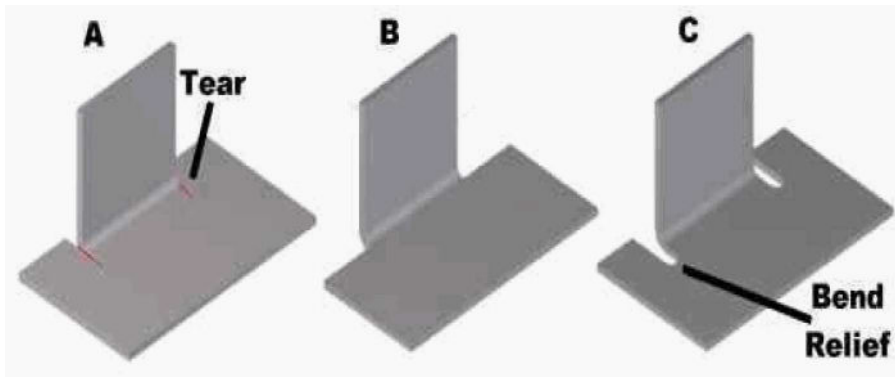

Forming Near Holes – When a bend is made too close to a hole, the hole may become deformed. Figure "A" shows a hole that has become teardrop shaped because of this problem. To save the cost of punching or drilling in a secondary operation the following formulas can be used to calculate the minimum distance required:

For a **hole < 1"** in diameter the minimum distance "D" = 2T + R (see fig. "B")

For a **slot or hole > 1"** diameter then the minimum distance "D" = 2.5T + R (see fig. "C")

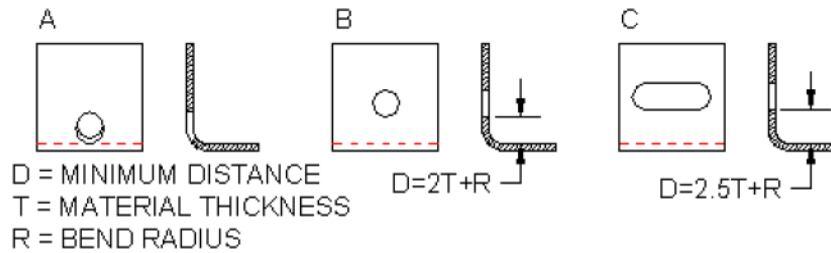

Form height to thickness ratio – To determine the minimum form height for sheet metal use the following formula: $D = 2.5T + R$ (see below) The height can be less but it required secondary operations and is far more costly.

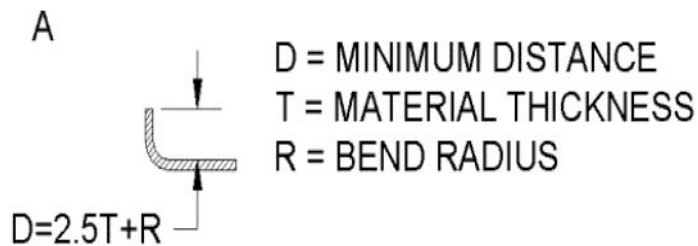

Edge Distortion – An exaggerated example of edge deformation is pictured in figure "A" below. The overhang caused by this distortion can be as large as $\frac{1}{2}$ the material thickness. As material thickness increases and bend radius decreases the overhang becomes more severe. In situations where an overhang is unacceptable the part can be relieved as in figure "B".

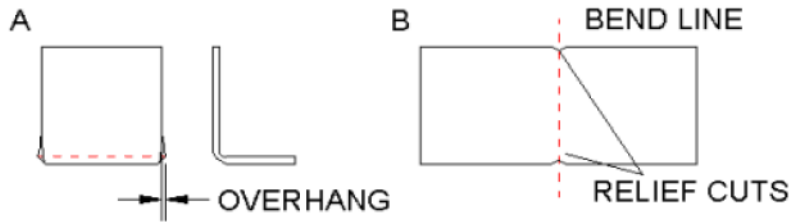

Laser Cutting Basics

With very little set up time, no tooling and the advent of CAD to CAM production, lasers are often utilized in prototyping and production parts. Well suited for intricate details and irregular contours, additional economies can be obtained through the nesting of parts when laser cutting.

Tolerances – The feature to feature tolerance on for the laser cutter is $\pm .004$ " but is typically held much closer. The smallest cut possible is dictated by the width of the beam or .008" wide.

Material restrictions – Materials have three factors that restrict them from laser cutting. These factors are reflectivity, thickness and flammability. Reflectivity causes a problem because the cutting beam gets scattered. Material that is too thick has the same problem: molten metal scatters the beam before the part is fully cut. We can cut metal as thick as $\frac{3}{8}$ " but the edge quality suffers greatly. The degree of material flammability is another important factor. Some parts considered flammable can be used. It is best to test flammable or heat sensitive materials before releasing a production part. Below is a list of some of the material we have used.

Acceptable Materials

- Any raw steel (Stainless, CRS, HRS)
- Aluminum Some deburring issues
- Plastic Check heat & flammability
- Cardstock Check heat & flammability
- Galvanized, Galvaneal

Unacceptable Materials

- Copper Highly reflective

- Paper stock Unless treated with flame retardant
- Silver & other prec. Metals Highly Reflective

Localized Hardening – Due to the intense heat associated with laser cutting, the edges of the material can become hardened. This area is referred to as the Heat Affected Zone (HAZ). This is especially important for secondary operations such as reaming and tapping. The HAZ increases in thicker materials.

Hole diameter – The entry diameter is larger than the exit diameter, creating a slightly tapered hole. Minimum hole sizes are related to stock thicknesses and can be as low as 20% of the stock thickness.

Turret Press Basics

CNC Turret presses are particularly suited for low to medium quantity production runs. By utilizing “soft tooling” or standard tooling, turrets lend themselves to both the highly flexible production of prototypes and inexpensive production quantities.

Tolerances – The feature to feature tolerance for the turret press is $\pm .004$ ”, the punched hole tolerance is $\pm .002$ ”. When dimensioning for the turret, select meaningful datum in the body of the part—passing through hole centers, if possible—rather than using an edge or corner of the part. Edges can be tapered or misaligned and result in enough variance to be dimensionally uncertain. Furthermore, the use of meaningful datum facilitates inspection.

Special forms – The turret punch press offers many versatile solutions for putting special features into a flat sheet. Some of the options are counter sinks, offsets, card guides, embosses, draws, wipe forms, part markings, lettering, lances, half-shears, and weld projections. Virtually any form can be made as long as it falls within the following constraints. The form depth must be less than 5/16" and it must fit into a 3.5" diameter circle. Progressive tools can also be made for the turret press. These tools can punch and form small parts as efficiently as a progressive punch press tool with a lower initial cost.

Hole to edge clearance – A good rule of thumb for hole placement is to keep the hole at least one material thickness away from any edge. If the hole gets too close to an edge a bulge can form as shown below. Also note, if the hole is used for fastening two pieces together, extra web

should be used to account for the added stress.

FIG "A"



Hole taper – When a hole is punched it does not have a constant radius through the entire thickness of the part. The cross section of a punched hole is shown below. The taper in the bottom side of the hole is relative to the die clearance. Die clearance is the difference between the punch diameter and die diameter. It is usually about 10% of the material thickness. To get a constant diameter through the entire material thickness the part must be drilled, a far more costly operation.

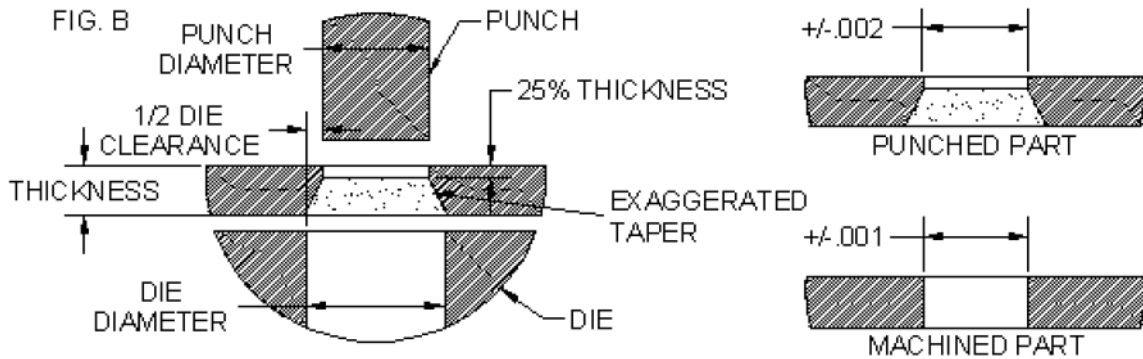

Hole diameter to thickness ratio – For most materials hole diameter should not be less than material thickness. As tensile strength increases the punch diameter must also increase.

Feature placement restrictions – When placing formed features next to one another, care should be taken allow clearance between features. If the station does not clear a form already placed in the part, the form could be flattened out. An example of good vs. bad placement is illustrated below. Relieving the stripper can overcome this problem in some cases.

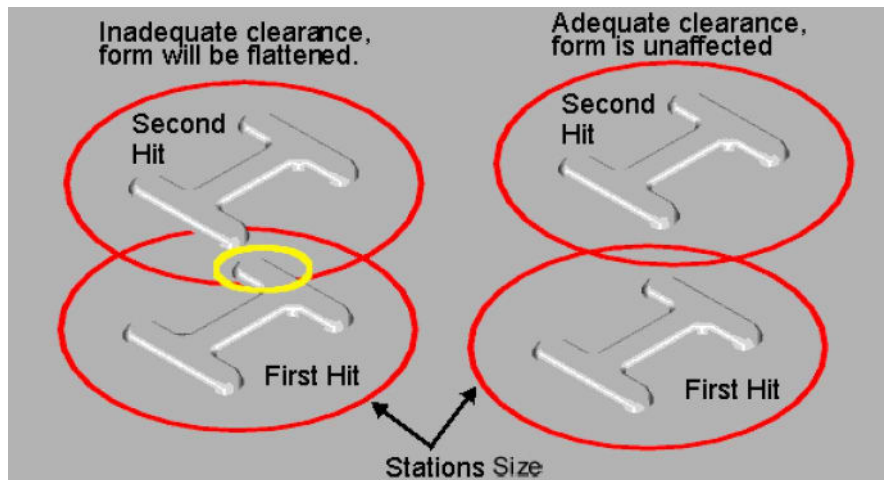

Nibbling large radii – When a large radius is required on a turret part the radius is made by making several hits with a flat tool. The angle and position of the tool changes as it moves around the edge simulating a large radius. The radius edge will have a "scalloped" look, tiny points formed where one flat is transitioned to another. The scalloped feature is pictured below. After deburring it is hardly perceivable, but still there.

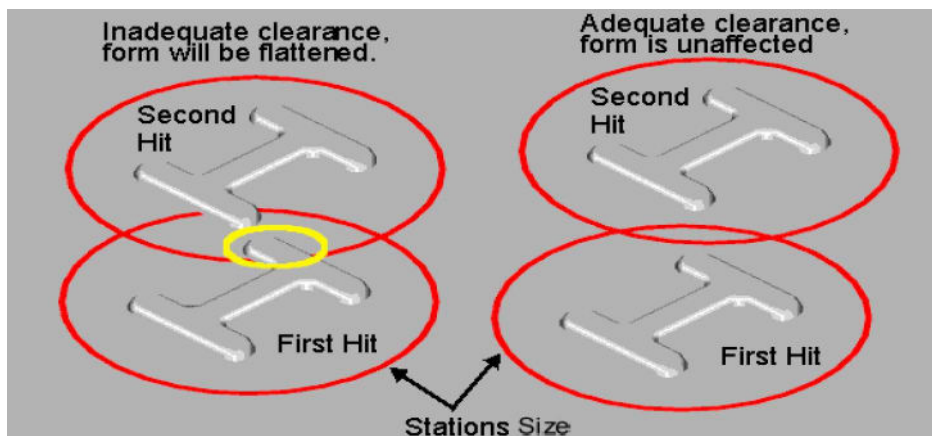

Counter sinks – A counter sink can be put in sheet metal by both machining and/or punching. Each of these methods give the finished part different characteristics. The cross sections of the features are shown below, they are listed from least to most expensive (tooling cost not included).

- Formed – Low Cost – Used for thin gages, 18 gage and lighter.
- Punched – Low Cost – Most common, used for anything heavier than 18 gage.
- Punched and Machined – Medium Cost – Used for harder materials that cannot be formed with a punch, e.g. heavy gage stainless.
- Machined Complete – High Cost – Rarely used, only for high tolerance applications or materials too thick to be punched.

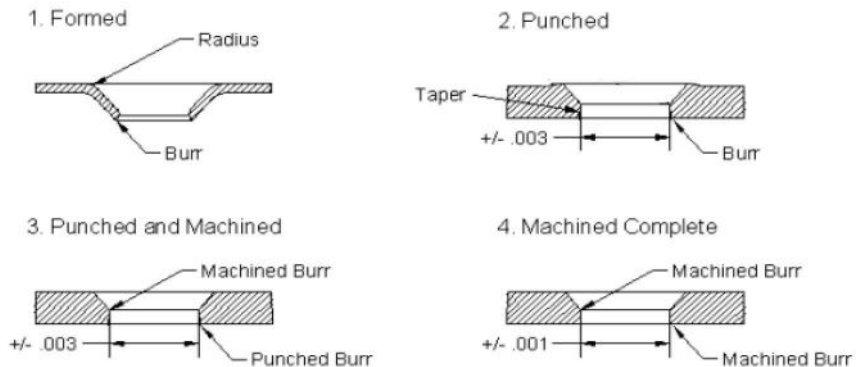

Stamping Basics

Involve us during design stage to optimize cost and performance in component design. Engineering changes can be costly.

While stamping offers precision and good reproducibility, consideration must be given to the amortization of tooling costs over the lifespan of production. Larger quantities typically justify more sophisticated tooling.

Blanking:

Dimension checks are made at the shear area or “cut band” (punch side) as the die side accuracy is affected by break out.

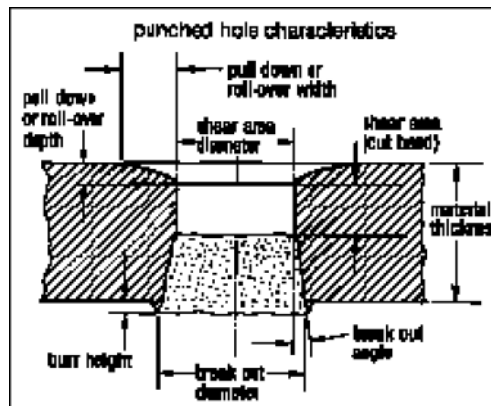

Corners- May be sharp, however to reduce tooling costs, specify radii of $\frac{1}{2}$ material thickness or a minimum of .015”.

Notches and Tabs- should not be narrower than 1.5X the material thickness. Length of notches can be up to 5X length of material thickness.

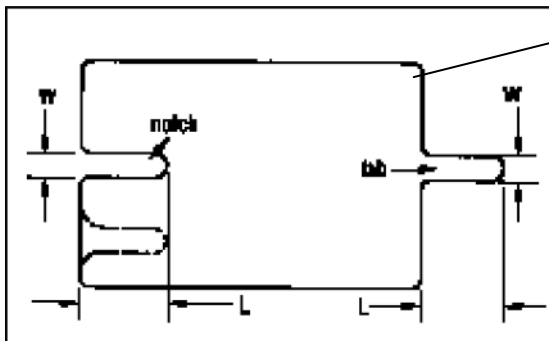

Recommend corner radius of $\frac{1}{2}$ material thickness.

Cutoffs:

There are three kinds of cutoffs in blanking: straight/square, half round or partial radius and full radius. The square cutoff is the most economical. The full radius is not recommended as it leaves an unavoidable “feather edge” burr along the outside material edge.

Piercing:

Holes-Minimum diameter of holes should be equal or greater than 1.2 X material thickness, and 2X material thickness for stainless steel or high tensile materials.

Edge-to-hole- Allow 2x material thickness (“web”) to prevent bulging of material

Forming:

Guidelines are similar to CNC press brake:

Bend Relief-Provide bend relief along L shaped features ($\text{Width}=2*T$ and $\text{Depth}=T +R$)

Edge bulging-restrictive tolerances on V bends may result in edge bulging—provide bend relief accordingly.

Hole-to-form-distance from hole-to-form—to avoid hole distortion, place holes no less than 2.5 times the material thickness + bend radius from the bend itself.

Slot-to-form-long slots should be spaced 4 X the material thickness plus the bend radius.

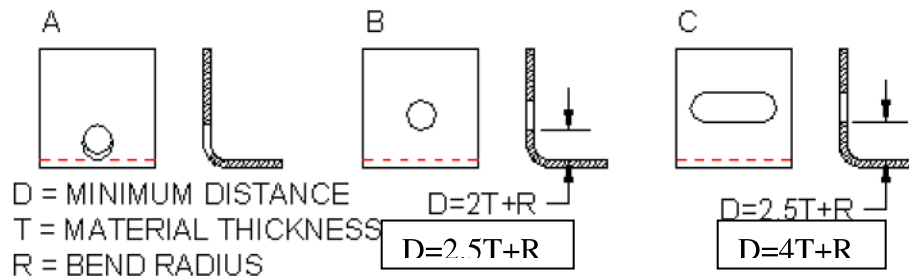

Drawing:

Shapes-A myriad of shapes can be formed through multiple draws. Round shapes offer that greatest ease and economy in drawing. Then next best option is square with adequate corner radii. Costs increase for combinations of basic shapes and irregular shapes.

Radii-To facilitate drawing, keep radii as generous as possible: punch and die radius should be a minimum of four times the material thickness. The part radius should be at no less than six times the material thickness with appropriate drawing-quality material.